

FRONT VIEW

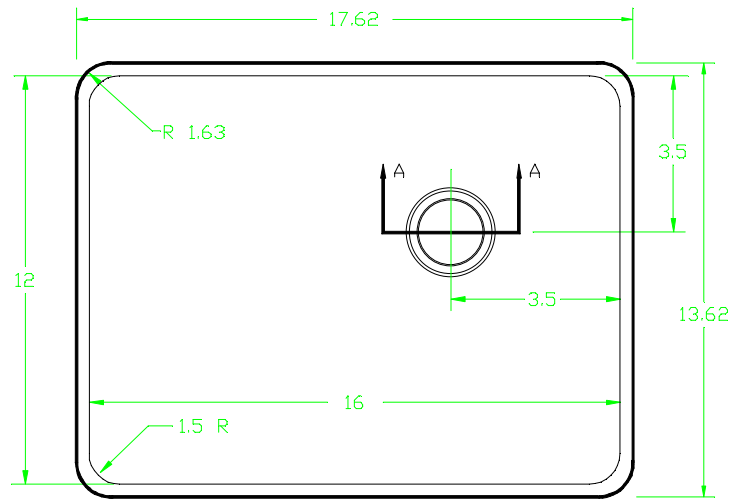

TOP VIEW

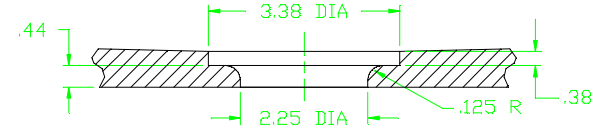

DRAIN OPENING DETAIL  
SECTION A-A

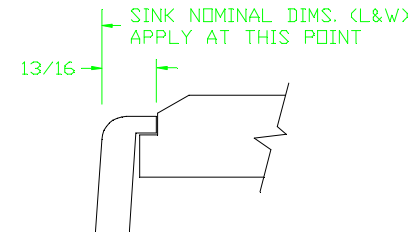

WALL DETAIL AT LIP

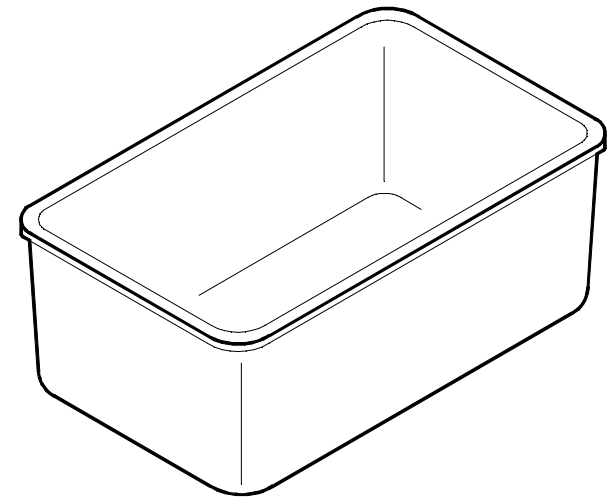

ISOMETRIC VIEW

DROP-IN SINK

NOTE: ALL DIMENSIONS REFLECT ACTUAL SINK SIZES +/- .0625

REV. # \_\_\_\_\_  
DATE: 9/08/98 KJR

SINK	WEIGHT	OUTLET LOCAL.	CODE
D15	30 LBS	CORNER	SNKD-15-*

**DURCON**<sup>TM</sup>  
INCORPORATED

DATE: 10/08/97  
SCALE: N.T.S.  
DRAWN: LDC/KJR  
FILE: D15.DWG