

FRONT VIEW

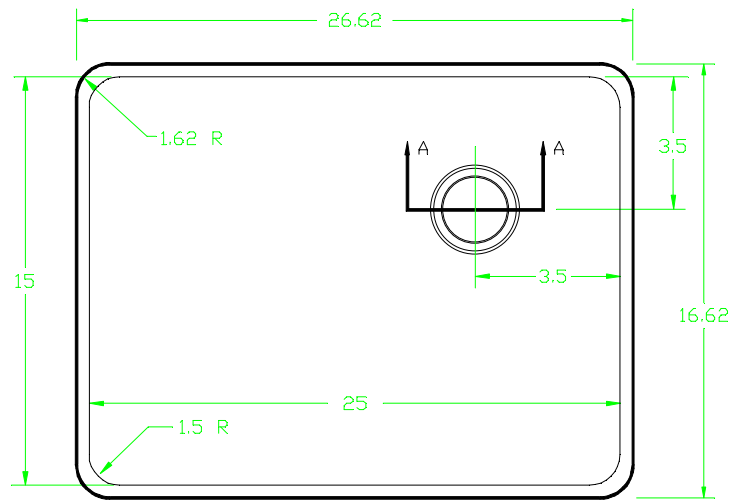

TOP VIEW

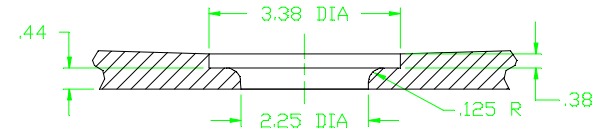

DRAIN OPENING DETAIL
SECTION A-A

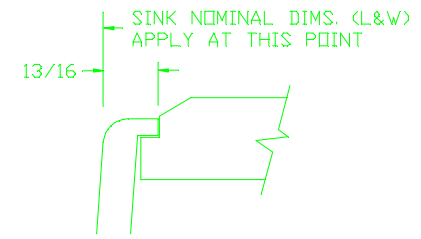

WALL DETAIL AT LIP

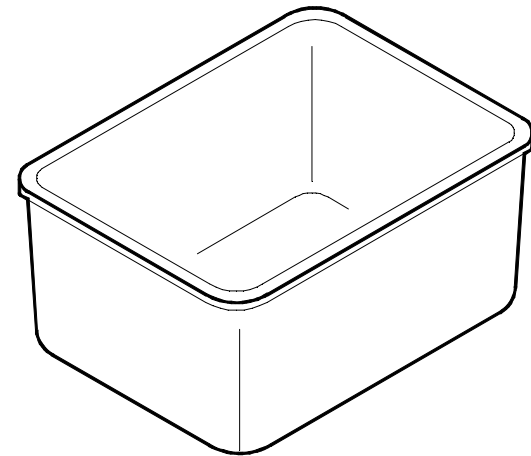

ISOMETRIC VIEW

DROP-IN SINK

NOTE: ALL DIMENSIONS REFLECT ACTUAL SINK SIZES +/- .0625

REV. # _____
DATE: 9/08/98 KJR

SINK	WEIGHT	OUTLET LOCAL.	CODE
D57	71 LBS	CORNER	SNKD-57-*

DURCONTM
INCORPORATED

DATE: 02/09/98
SCALE: N.T.S.
DRAWN: LDC/KJR
FILE: D57.DWG