

FRONT VIEW

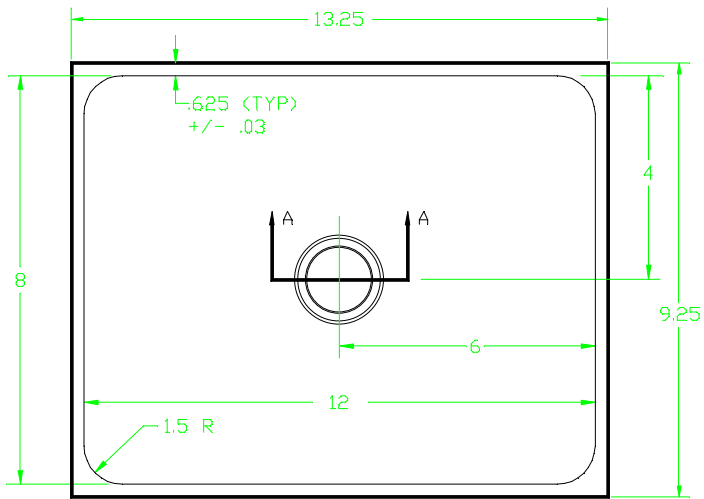

TOP VIEW

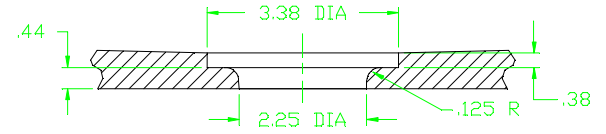

DRAIN OPENING DETAIL
SECTION A-A

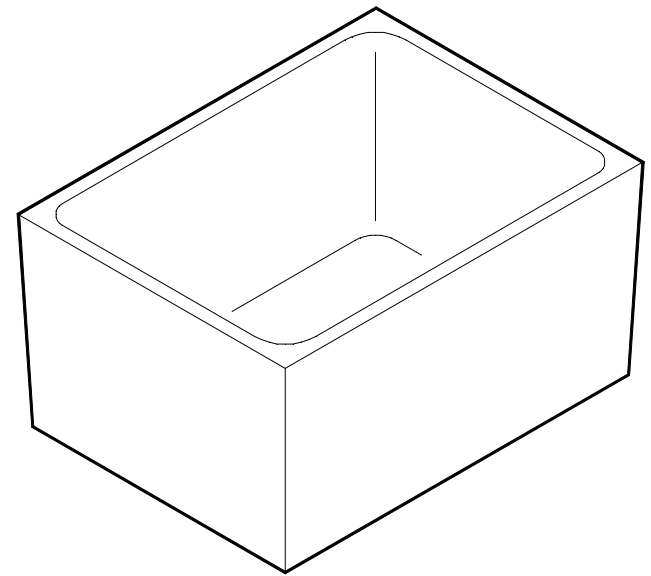

ISOMETRIC VIEW

UNDER MOUNT SINK

NOTE: ALL DIMENSIONS REFLECT ACTUAL SINK SIZES +/- .0625

REV. # _____
DATE: _____

SINK

WEIGHT

OUTLET LOCAL.

CODE



Laboratory Tops, Inc.

U03

17 LBS.

CENTER

SNK-U03

DATE: 10/09/97
SCALE: N.T.S.
DRAWN: LDC/KJR
FILE: U03.DWG