

FRONT VIEW

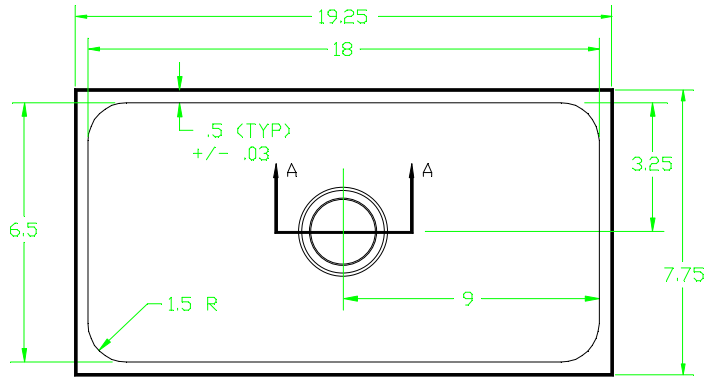

TOP VIEW

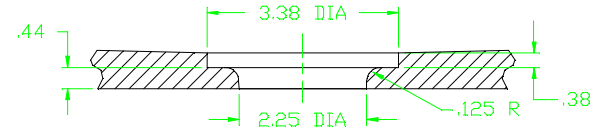

DRAIN OPENING DETAIL
SECTION A-A

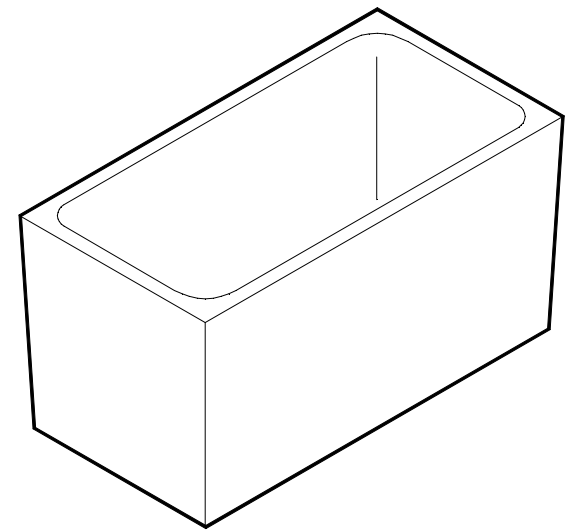

ISOMETRIC VIEW

UNDER MOUNT SINK

NOTE: ALL DIMENSIONS REFLECT ACTUAL SINK SIZES +/- .0625

REV. # _____
DATE: _____

SINK	WEIGHT	OUTLET LOCAL.	CODE
U22	22 LBS.	CENTER	SNK-U22



Laboratory Tops, Inc.

DATE: 10/10/97
SCALE: N.T.S.
DRAWN: LDC/KJR
FILE: U22.DWG