

FRONT VIEW

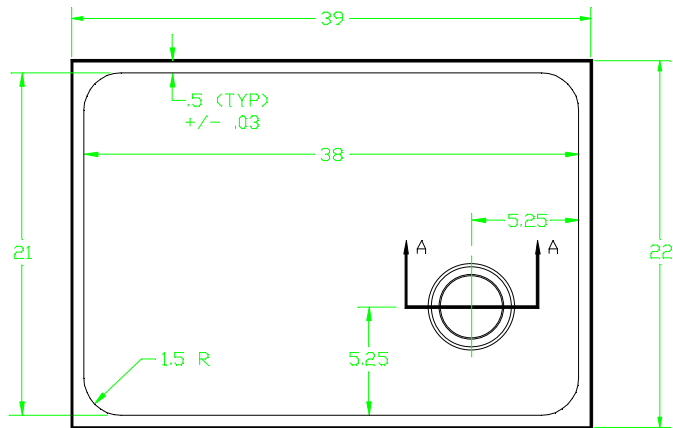

TOP VIEW

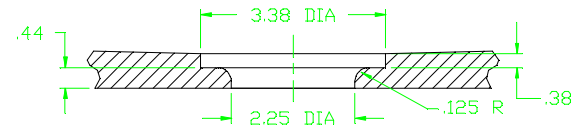

DRAIN OPENING DETAIL  
SECTION A-A

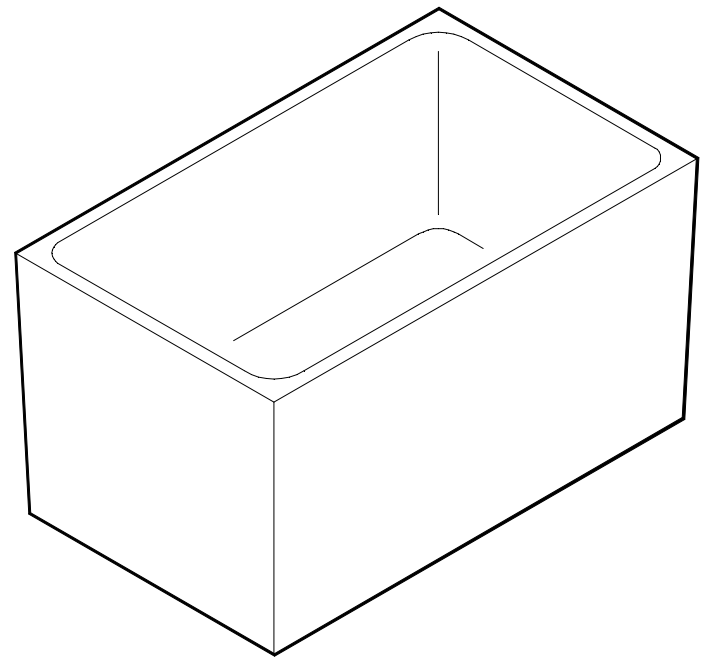

ISOMETRIC VIEW

UNDER MOUNT SINK

NOTE: ALL DIMENSIONS REFLECT ACTUAL SINK SIZES +/- .0625

REV. # \_\_\_\_\_  
DATE: \_\_\_\_\_

SINK	WEIGHT	OUTLET LOCAL.	CODE
U73	150 LBS.	CORNER	SNK-U73



Laboratory Tops, Inc.

DATE: 10/10/97  
SCALE: N.T.S.  
DRAWN: LDC/KJR  
FILE: U73.DWG