

FRONT VIEW

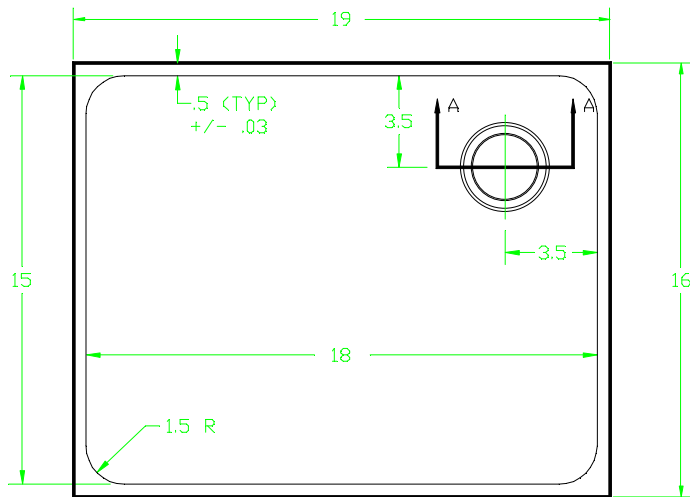

TOP VIEW

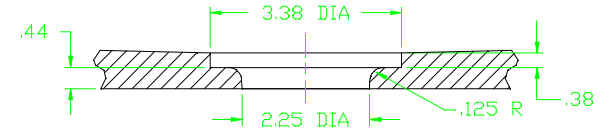

DRAIN OPENING DETAIL  
SECTION A-A

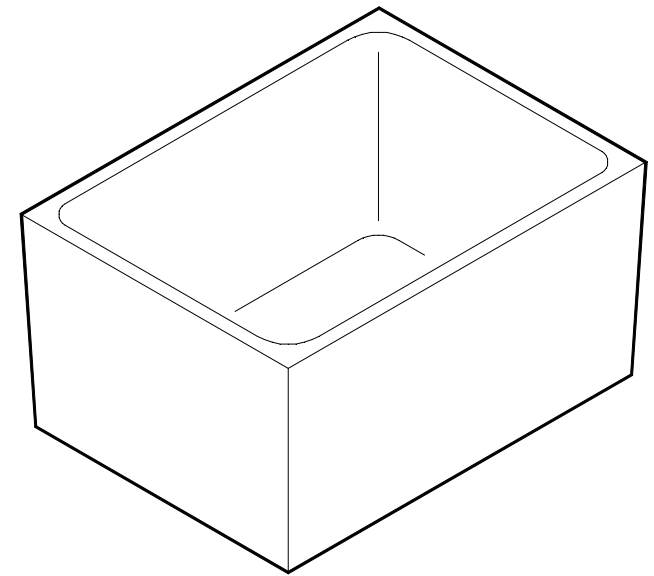

ISOMETRIC VIEW

UNDER MOUNT SINK

NOTE: ALL DIMENSIONS REFLECT ACTUAL SINK SIZES +/- .0625

REV. # \_\_\_\_\_  
DATE: \_\_\_\_\_

SINK

WEIGHT

OUTLET LOCAL.

CODE



Laboratory Tops, Inc.

U25

40 LBS.

CORNER

SNK-U25

DATE: 10/10/97  
SCALE: N.T.S.  
DRAWN: LDC/KJR  
FILE: U25.DWG